



COMPONENT OVERVIEW 2020

SCHLETTER
The Solar Mounting Group

General information

Materials:

Roof hooks and their main components:
Highgrade steel with zinc flake coating,
stainless steel 1.4301 or aluminium

Screws:
Stainless steel A2 or better

Sheet metal parts:
Stainless steel 1.4301 or aluminium.

Module clamps:
Aluminium

Rubber seal:
EPDM gasket (UV-resistant)

Deviating materials are described with the individual items.

Planning aid:

Configuration and structural dimensioning with the
Schletter Configurator

Structural analysis:

Static calculation according to the current country-specific standards (in Germany EN 1991, EC1). Structural analysis supplement for the dimensioning of the number of required fastening points, based on the structural analysis. Please make sure you observe the structural analysis information in each case! The verification of the adhesive force of the roof to the substructure is not included in the general structural analysis appendices!

Production-specific tolerances are to be considered with all dimension specifications.

On customer request, all companies of the Schletter Group can purchase goods from Schletter Germany and China (Shanghai). Both have been certified according to ISO 9001. Further details about the certifications are available on the respective Schletter websites.

TABLE OF CONTENTS

Component overview

Presentation

Brochures and software	06
Sample case	07

Roof hooks

Standard roof hooks	10
Rapid ²⁺ roof hooks	11
Roof hooks HSL	12
Roof hooks EcoA	12
Alu-Tile	13
Roof hooks, special design	14
Roof hook accessories	17

Special fasteners

Special fasteners for roofs with steel substructure	20
Special fasteners for roofs with wooden substructure	22
Special fastener accessories	23
Sheet metal seam clamps	24
System VarioFix / SingleFix / FixZ mounting kit / EcoRapid	26
ClampFit / Fix T-K	27

Module clamps

Module clamps for framed modules	30
Clamps for laminate modules	32
Laminate clamp accessories	34

Profiles

Module support and mounting profiles	38
Profile accessories	40

Supports

Flat roof supports - Beam kit	44
Flat roof support/Facade support - Beam kit	45
Beam kit accessories	46
Support accessories	47

Load-optimized flat roof systems

FixGrid	50
FlatGrid	53

PVMax Energy-Kits

PVMax S Kit	56
-------------	----

Screws and small parts

Screws and small parts	60
------------------------	----



PRESENTATION

Brochures and Software

Sample case

BROCHURES AND SOFTWARE

Presentation



The latest brochures, product sheets, mounting instructions and further technical information as well as software can always be found in the download area of www.schletter-group.com

Upon request, we will also gladly send you our brochures in digital format.

SAMPLE CASE

Presentation



Similar illustration

Upon request!

195000-297 Sample case of roof and standard systems
Contains samples of major products of the
Schletter mounting systems



ROOF HOOKS

Standard roof hooks

Rapid²⁺ roof hooks

Roof hooks HSL

Roof hooks EcoA

Alu-Tile

Roof hooks, special design

Roof hook accessories

STANDARD ROOF HOOKS

Roof hooks

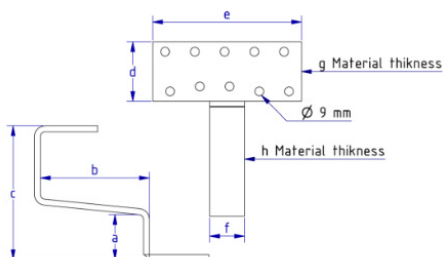

- All roof hooks made of stainless steel
- Adjustable hooks completely pre-assembled

Wood screws, square head bolts (M10 x 25 mm) and flange nuts must be ordered separately.

Roof hooks Eco S

- VA quality
- Welded
- Symmetric bar arrangement



100004-000 Eco S 135 roof hooks (normal height 135 mm)

	a	b	c	d	e	f	g	h	
mm	45	110	135	60	150	35	5	6	PU:20

100007-000 Eco S 165 roof hooks (normal height 165 mm)

	a	b	c	d	e	f	g	h	
mm	45	110	165	60	150	35	5	6	PU:20

Universal roof hooks

- VA quality
- Variable bar arrangement
- Adjustable at the front and rear
- Center bar can be used in three positions



100001-000 Universal roof hooks (Frankfurt pantile or interlocking tiles)

	a	b	c	d	e	f	g	h	
mm	42-52	115	102-135	74	150	30	5	6	PU:20

RAPID²⁺ ROOF HOOKS

Roof hooks

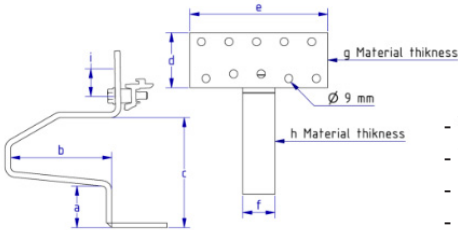

- VA quality
- Welded
- Symmetric bar arrangement
- Pre-assembled



101001-000 Rapid²⁺ roof hooks 45

	a	b	c	d	e	f	g	h	i	
mm	45	110	118	60	150	35	5	6	30	PU:20

Comparable to: Eco S 100004-000

101002-000 Rapid²⁺ roof hooks 35

	a	b	c	d	e	f	g	h	i	
mm	35	110	108	60	150	35	5	6	30	PU:20

Like 101001-000, but 35 mm / 1.38-inch fork height for low battens

101004-000 Rapid²⁺ Universal roof hooks

	a	b	c	d	e	f	g	h	i	
mm	40-52	110	115-127	74	150	35	5	6	30	PU:10

Universally adjustable, for vertical rail mounting

Comparable to: Universal 100001-000

101005-000 Rapid²⁺ Max roof hooks

	a	b	c	d	e	f	g	h	i	
mm	45	120	125	80	150	35	6	8	30	PU:10

Like 101001-000, but bar 35 x 8 mm / 1.38 x 0.31 inches for heavy snow loads

101005-001 Rapid²⁺ Max roof hooks 150

	a	b	c	d	e	f	g	h	i	
mm	45	150	125	80	150	35	6	8	30	PU:10

Like 101005-000, but measure b 150 mm

101006-000 Rapid²⁺ MaxV roof hooks

	a	b	c	d	e	f	g	h	i	
mm	45	120	125	80	150	35	6	8	30	PU:10

Like 101005-000, but for vertical rail mounting

ROOF HOOKS HSL

New: Made of highgrade steel, especially for high snow loads

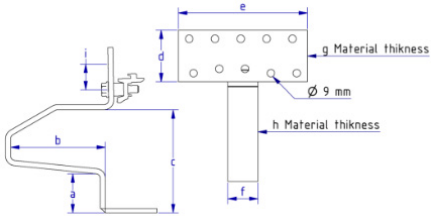

- Material: highgrade steel, welded
- Coating: Zinc Flake coating
- Symmetric bar arrangement
- Pre-assembled



100018-000 Roof hooks Eco S HSL

	a	b	c	d	e	f	g	h	i	j	
mm	45	110	120	80	150	35	5	6		9	PU:20



101001-002 Roof hooks Rapid2+ 45 HSL

	a	b	c	d	e	f	g	h	i	j	
mm	45	110	115	80	150	35	5	6	30	9	PU:20



101005-004 Roof hooks Rapid2+ Max HSL

	a	b	c	d	e	f	g	h	i	j	
mm	45	132	114	80	150	35	6	8	30	9	PU:10

ROOF HOOKS EcoA

New: Made of aluminium. Light, low cost, efficient

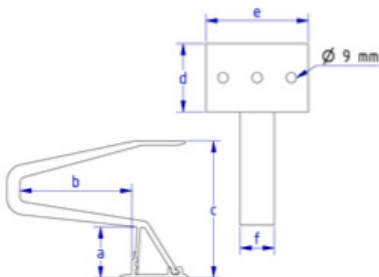

- Material: Aluminium
- Mounting with only one bolt
- Variable bar arrangement



100020-000* Roof hook EcoA 45

	a	b	c	d	e	f	
mm	45	99	120	60	90	30	VPE:20

* New: available from the 4th quarter

ALU-TILE

Roof hooks

Replaces a complete roof tile. Please order roof hook set separately. Especially for areas with heavy snow loads.

System hooks with sheet metal replacement tiles in aluminum, EPDM screw seal, load support in plastic with A2 stainless-steel screw.

Sheet metal replacement tiles

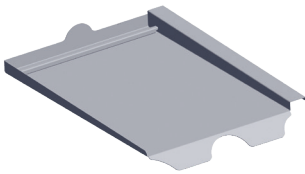

Manufacturer	Item No.	PU:10
Braas		
Frankfurt pantile	103005-003	
Taunus pantile	103005-011	
Harz pantile	103005-022	
Tegalit	103005-025	
Topas 13V	103005-067	
Erlus		
Interlocking tile	103005-002	
Large interlocking tile	103005-007	
Large interlocking tile XXL	103005-010	
E58	103005-015	
Forma	103005-024	
Linea	103005-049	
Reform pantile XXL	103005-057	
Eternit		
Heidelberger	103005-006	
Meindl		
Rustico	103005-004	
MZ3 NEW	103005-112	

Other sheet metal replacement tiles are available on request.

Alu-Tile roof hook set

Consists of system hook, screw seals and load support

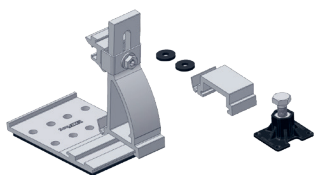

103006-000 Alu-Tile roof hook set

PU:10

ROOF HOOKS, SPECIAL DESIGN

Roof hooks

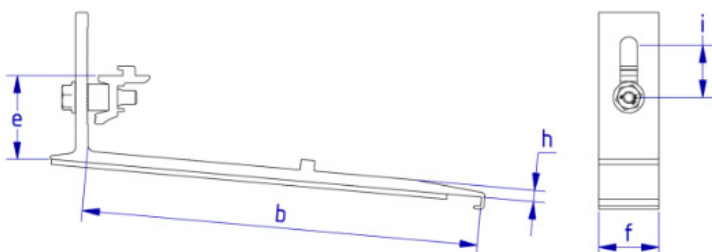

Sheet metal replacement tiles and roof hook sets for Rapid beaver tail incl. mounting set

109016-007 BEZ Rapid beaver tail AL 180 x 380 PU:20

109019-000 Roof hooks for Rapid beaver tail AL inst. PU:20

	a	b	c	d	e	f	g	h	i
mm	-	228	-	-	48	35	-	7	30

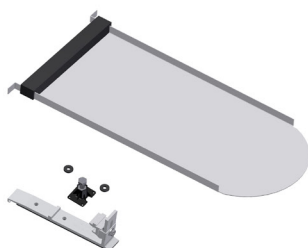

109016-009 BEZ Rapid beaver tail AL 170 x 380 PU:20

109019-000 Roof hooks for Rapid beaver tail AL inst. PU:20

	a	b	c	d	e	f	g	h	i
mm	-	228	-	-	48	35	-	7	30



109016-010 BEZ Rapid beaver tail AL 190 x 400 PU:20

109019-002 Roof hooks for beaver tail Rapid inst. 190 x 400 PU:20

	a	b	c	d	e	f	g	h	i
mm	-	250	-	-	50	35	-	6	30

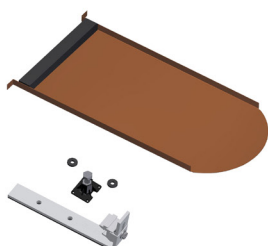

109016-008 BEZ Rapid beaver tail Cu 180 x 380 PU:20

109019-001 Roof hooks for Rapid beaver tail Cu inst. PU:20

	a	b	c	d	e	f	g	h	i
mm	-	232	-	-	50	35	-	6	30

ROOF HOOKS, SPECIAL DESIGN

Roof hooks

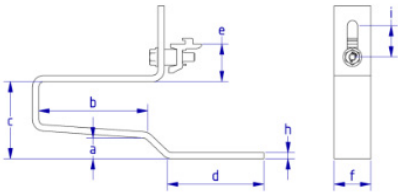

Rapid 2L roof hooks

Roof hooks for system roofs made of roof insulation elements

101008-000 Rapid 2L roof hooks										PU:20
	a	b	c	d	e	f	g	h	i	
mm	20	104	74	92	36	35	-	6	30	

101008-002 Rapid 2LV roof hooks										PU:20
	a	b	c	d	e	f	g	h	i	
mm	20	100	74	92	46	35	-	6	30	

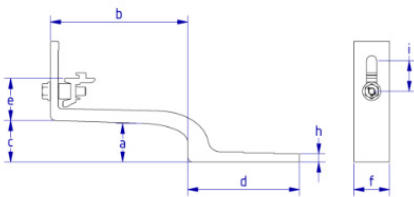

Rapid²⁺ Slate roof hooks

- Quick and easy mounting
- Suitable for many shingle types
- Roof panel with flexible corrugated strip
- Direct load on rafters

109019-004 Roof hook Rapid²⁺ Slate125 (shingleless)

109017-010 Shingle for roof hook Rapid²⁺ Slate125

For slate overlaps up to 125mm										PU:20
	a	b	c	d	e	f	g	h	i	
mm	28	135	41	110	41	35	-	8	30	

ROOF HOOKS, SPECIAL DESIGN

Roof hooks

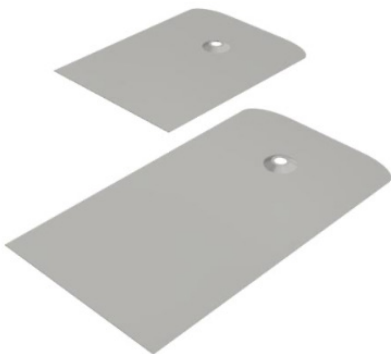
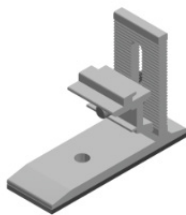
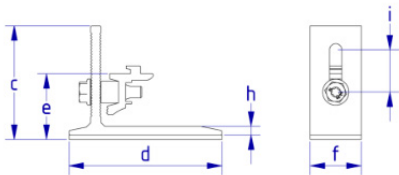

Rapid²⁺ SML

119026-101 Rapid ²⁺ SML roof hooks									PU:20
	a	b	c	d	e	f	g	h	i
mm			78	105	45	35		6	29

SlatePlan for attachment with hanger bolts

SlatePlan can be used on roofs with shingle covers, such as from bitumen, fiber cement or slate, for connection by hanger bolt systems. For accessories, see hanger bolts (page 22)

109017-000 SlatePlan with seal 270 x 200 x 0.5 mm	PU:50
109017-001 SlatePlan with seal 370 x 200 x 0.5 mm	PU:50

ROOF HOOK ACCESSORIES

Roof hooks



973000-075 Spacer plate roof hook 2,5/5 mm	PU:100
---	--------

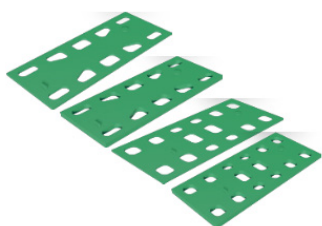

973000-017* EcoG / EcoS 2 mm shim / Rapid Standard	PU:50
---	-------

973000-018* EcoG / EcoS 5 mm shim / Rapid Standard	PU:50
---	-------

973000-019* Shim 2 mm VaMax / Rapid Max	PU:50
--	-------

973000-020* Shim 5 mm VaMax / Rapid Max	PU:50
--	-------

Spacer for roof hook mounting

* Products run out and will be replaced by 1 universal shim



973000-683 Roof hook sealing tape grey TP600 10 m	PU:15
--	-------

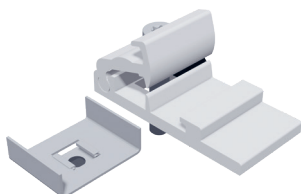

109008-003 RapFix - extension for Eco roof hooks Especially for roof hooks that are not available as a rapid version	PU:50
---	-------



925120-002 Spacer sleeve, plastic, 1 m	
- For rafter insulation	
- Usable as a spacer sleeve for rafter insulation in connection with extra-long fastening screws	
- Plastic version prevents cold bridges	
- Cut to desired length	
- Order screws separately!	
- Note reduced load for roof hooks!	



109010-000 Additional bracket Iso07 For roof hook fastening, system Iso07	PU:20
---	-------



SPECIAL FASTENERS

Special fasteners for roofs with steel substructure

Special fasteners for roofs with wooden substructure

Special fastener accessories

Sheet metal seam clamps

System VarioFix / SingleFix / FixZ mounting kit / EcoRapid

ClampFit / Fix T-K

SPECIAL FASTENERS FOR ROOFS WITH STEEL SUBSTRUCTURE

Roof cladding: Corrugated roofs & trapezoidal sheet



Threaded screw, self-grooving, VA

943763-064 6,3x64	PU:100
943763-115 6,3x115	PU:100
943763-150 6,3x150	PU:100
943763-200 6,3x200	PU:50

+ adapter

= ready to use
Fastening systems

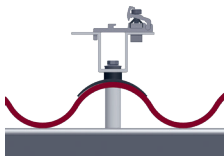

119033-002 Uno M8 universal adapter	PU:50
119005-000 Seal cap for corrugated sheets 5 / 6 / 8	PU:50
119004-002 Spacer sleeve AL 65 x 20*	PU:50
119004-003 Spacer alu 995 x 20**	PU:30

* for profile height 57 mm

** for other profile heights, these must be cut to size at the construction site
Rapid cross connectors (item 129063-000) must be ordered separately



x 2

x 2

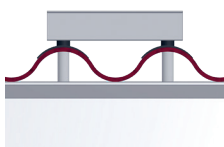

119033-005 Duo M8 universal adapter	PU:50
119005-000 Seal cap for corrugated sheets 5 / 6 / 8	PU:50
119004-002 Spacer sleeve AL 65 x 20*	PU:50
119004-003 Spacer alu 995 x 20**	PU:30

For each mounting point, 2 threaded screws must be calculated

* For profile height 57 mm

** For other profile heights, these must be cut to size at the construction site

SPECIAL FASTENERS FOR ROOFS WITH STEEL SUBSTRUCTURE

Roof cladding: Corrugated roofs & trapezoidal sheet

+ adapter

= ready to use
Fastening systems

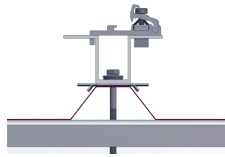
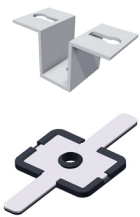

119033-002 Uno M8 universal adapter	PU:50
119005-001 Universal sphere cap with EPDM	PU:50

Rapid cross connectors (item 129063-000) must be ordered separately

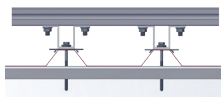
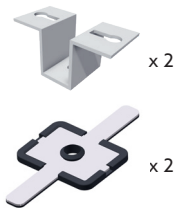

119033-002 Uno M8 universal adapter	PU:50
119005-001 Universal sphere cap with EPDM	PU:50

For each mounting point, 2 threaded screws must be calculated

Additionally, the upper profile and the necessary mounting screws must be considered

SPECIAL FASTENERS FOR ROOFS WITH WOODEN SUBSTRUCTURE

Roof cladding: Corrugated roofs & trapezoidal sheet

For corrugated sheets (such as those of fiber cement) or trapezoidal sheet roofs, corrugated roof fastening sets consisting of a special hanger bolt with EPDM seal and a mounting plate are used. Please note that illustrations and thread lengths may vary!



Hanger bolt

110010-200 Hanger bolt set 10 x 200 mounted	PU:50
110012-200 Hanger bolt set 12 x 200 mounted	PU:50
110012-300 Hanger bolt set 12 x 300 mounted	PU:50

Hanger bolt set pre-assembled with vulcanized EPDM seal (UV resistant) and 3 flange nuts in V4A, mounted

+ adapter

= ready to use
Fastening systems



119002-000 Mounting plate for hanger bolt M10 / M12 For hanger bolts M10 / M12, loose, aluminum 120 x 60 x 6 mm	PU:50
---	-------



119001-000 KlickTop extension part for hanger bolt For M10 / M12 hanger bolts, loose, aluminum	PU:50
--	-------



119033-004 Universal adapter Duo M10 / M12 For M10 / M12 hanger bolts, loose, aluminum	PU:50
--	-------



119033-001 Universal adapter Uno M10 / M12 For M10 / M12 hanger bolts, loose, aluminum	PU:50
--	-------

Rapid cross connectors (item 129063-000) must be ordered separately

SPECIAL FASTENER ACCESSORIES

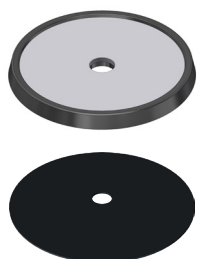

FixPlan - in connection with hanger bolts

The alternative for level sheet metal roofs for which fastening on the fold is not possible (e.g. titanium zinc sheet roofs)

114003-000 FixPlan sealing plate	PU:50
114004-000 Bituplan additional seal for FixPlan For mounting with bitumen coverings	PU:100

SHEET METAL SEAM CLAMPS

Special fasteners

Please note: The tightening torque must be limited so that the sheet metal seam does not become distorted and the thermal expansion of the sheets is not prevented!



112001-000 Seam clamp 503 VA for standing seam roof	PU:50
Please note: For titanium zinc sheets, it must be checked whether the fold can be stressed!	



112001-005 Seam clamp 503 Rapid for standing seam roof	PU:50
---	-------



112001-010 Seam clamp 504 AL KK for standing seam roof	PU:50
Especially suitable for double standing seam roofs made of titanium zinc sheet	

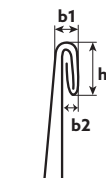

Possible dimensions of the border fold (left dimension drawing)
 $h = 11-13 \text{ mm}$, $b1 = 4-6 \text{ mm}$, $b2 = \text{max. } 3 \text{ mm}$

The 504 seam clamp was developed together with the Rheinzink company for use on double standing seam roofs made of titanium zinc sheet and approved by Rheinzink. The profiles mounted on the standing seam clamps must not exceed a length of about 3 m without thermal separation.



112002-003 Seam clamp 510 AL Rapid for KalZip and similar	PU:50
--	-------



112003-003 Seam clamp 520 Rapid Zambelli RibRoof465 and similar	PU:50
--	-------

SHEET METAL SEAM CLAMPS

Special fasteners



112004-002 Seam clamp 522 AL Rapid Zambelli RibRoof500 and similar PU:50



112006-002 Seam clamp 524 Rapid Fischer KlipTec and similar PU:50



112007-000 Seam clamp 525 VA for Domico Domitec for Domico and similar PU:50



112012-002 Seam clamp 540 AL KK for KlipLok 700 / 406 for KlipLok 700 HiStrength, Classic 700 / 406 and similar PU:50

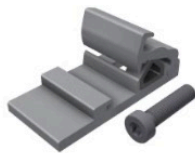

Attachment for seam clamps of other suppliers

109008-004 RapFix - attachment flush M8 bolt for connection in set PU:50

SYSTEM VARIOFIX / SINGLEFIX / FIXZ MOUNTING KIT / ECORAPID

Special fasteners

The universal trapezoidal sheet fastener for steel and aluminum sheet from 0.5 mm. Pay special attention to the usage notes!



113014-000 EcoRapid - clamp directly on frame for corrugation heights from 22 mm Screws must be ordered separately as needed Item number: 943000-360 EcoRapid on edge of module field: 2 screws EcoRapid in center of module field: 1 screw	PU:200
--	--------

SingleFix-V Solo

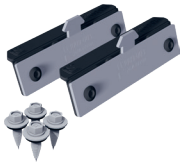

113009-103 SingleFix-V Solo 20-pair set for corrugation heights from 22 mm (2 x SingleFix-V Solo, 4 sheet metal screws) Used in connection with Solo mounting rails, for example	PU:50
---	-------

+ Profile

= Mounting kit

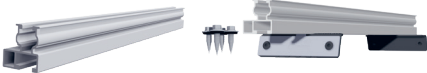

120011-00450 EcoLight 450 mm module support profile	PU:50
--	-------



121010-202 FixZ-7 system profile 18 lower 450 mm	PU:25
---	-------



121001-202 FixZ-7 upper system profile 18 450 mm	PU:25
---	-------



121009-202 FixZ-15 system profile 18 lower 450 mm	PU:25
--	-------

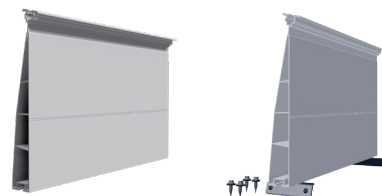

121008-202 FixZ-15 upper system profile 18 450 mm	PU:25
--	-------

CLAMPFIT

Special fasteners



The cost-optimized trapezoidal sheet fastener system for steel and aluminum sheet from 0.5 mm. Pay special attention to the usage notes!

130004-100 ClampFit fastener	PU:100
Module clamps additionally needed depending on the frame height	

FIX T-K

Special fasteners

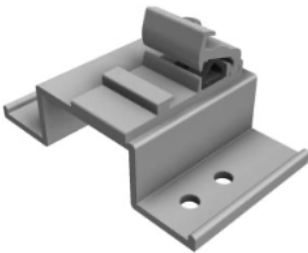

The innovative fastener for bitumen roofs on wood casings

119014-012 Fix T-K	PU:50
Please note, accessories: 973000-041 EPDM rubber (page 62)	



MODULE CLAMPS

Module clamps for framed modules

Clamps for laminate modules

Laminate clamp accessories

MODULE CLAMPS FOR FRAMED MODULES

Module clamps

Rapid16 AL module clamp system

Clamping length: 50 mm

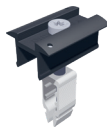

AL blank	Black anodized item designation	Installation type
131121-002	131121-902 Rapid16 center clamp 40-50	V + H PU:100



131101-002	131101-902 End clamp Rapid16 40-50	V + H PU:50
-------------------	---	--------------------



131121-001	131121-901 Rapid16 center clamp 30-40	V + H PU:100
-------------------	--	---------------------



131101-001	131101-901 Rapid16 end clamp 30-40	V PU:50
-------------------	---	----------------



131101-003	131101-903 Rapid16 end clamp 30-40	H PU:50
-------------------	---	----------------

MODULE CLAMPS FOR FRAMED MODULES

Module clamps

Rapid16 AL module clamp system

Clamping length: 100 mm



AL blank	Black anodized item designation	Installation type
131121-112	Middle clamp Rapid16 40 - 50 L	V + H PU:100



131121-111	Middle clamp Rapid16 30 - 40 L	V + H PU:100
------------	--------------------------------	--------------

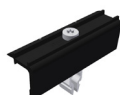

131101-101	131101-191 End clamp Rapid16 30 - 40 L	V PU:50
------------	--	---------



131101-102	131101-192 End clamp Rapid16 40 - 50 L	V + H PU:50
------------	--	-------------

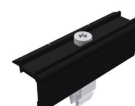

131101-103	131101-193 End clamp Rapid16 H 30 - 40 L	H PU:50
------------	--	---------

CLAMPS FOR LAMINATE MODULES

Module clamps

Profi and Eco laminate series

For various module thicknesses
 Attention: Note the tightening torque!
 (See also: General information on laminate mounting)

Profi laminate series

For laminate thicknesses 3-14 mm
 Glass inset: Profi narrow 11 mm, Profi wide 15 mm
 Length: 80 mm, clearance between modules: approx. 20 mm
 Incl. countersunk screw and square nut

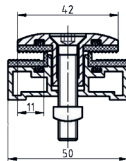
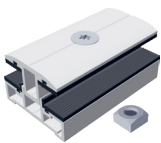

132201-308 Profi center clamp narrow 3-8 mm set	PU:200
--	--------

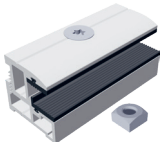

132101-308 Profi end clamp narrow 3-8 mm set	PU:200
---	--------

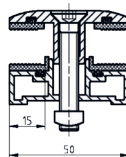
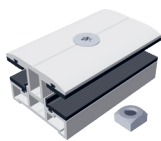

132202-308 Profi center clamp wide 3-8 mm set	PU:200
--	--------

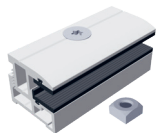

132102-308 Profi end clamp wide 3-8 mm set	PU:200
---	--------

CLAMPS FOR LAMINATE MODULES

Module clamps

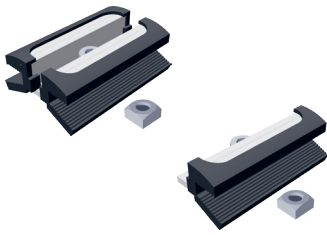

Eco laminate series

Length of aluminum clamp: 70 mm, glass inset: 11 mm, clearance between modules. 22 mm, (no compression of the laminate)

133264-168 Eco6-S4 center clamp laminate 6.8 mm set	PU:100
133164-168 Eco6-S4 end clamp laminate 6.8 mm set	PU:100

With M8 x 20 accessories, without click-in component

With aluminum clamp surrounding EPDM rubber

Certified clamps for First Solar series 4 modules made of highly insulated EPDM rubber material. The certification can be found in the download area at www.schletter-group.com

LAMINATE CLAMP ACCESSORIES

Module clamps



AL blank

139004-000 Bearing plate for Eco module clamp
For raising the bearing surface

PU:200

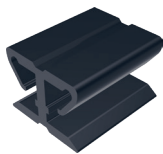

973000-012 Spacer

For laminate thicknesses 4-10 mm

PU:100

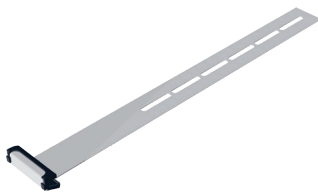

AL blank

139008-006 Safety hooks, laminate 3-8 mm

PU:100

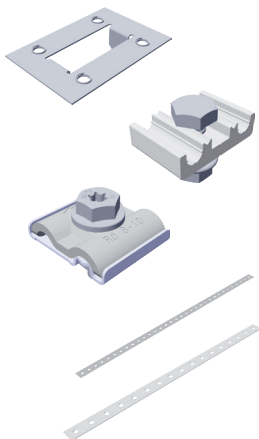

Lightning protection and potential equalization

135004-000 Ground plate
for module grounding, not for laminate clamps!

PU:100

135003-000 Lightning protection clamp for 8 mm
AL completely pre-assembled (for DM 8 mm wiring)

PU:20

135003-002 Grounding and lightning protection clamp VA M8
Clamping range Rd 8-10 mm
Connection single / multi-wire 4-50 mm²

PU:20

119015-002 Punched mounting tape 6-50 m

PU:1

119015-003 Punched mounting tape 16-50 m
lightning resistant

PU:1



PROFILES

Module support and mounting profiles

Profile accessories

MODULE SUPPORT AND MOUNTING PROFILES

Profiles

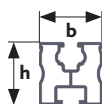

The series for the proven click system with the right accessories

Mounting with square nut, click system and Rapid²⁺

- Structural analysis tables for cross beams

- Load determination software on the Internet:

www.schletter-group.com

(Customer area > Software Download)

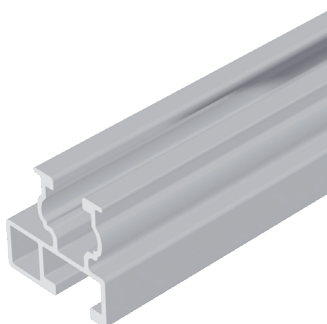

Module support profile EcoLight

Mechanical connection

Upper: KlickNut M8
Lower: Screw channel M10

b	h
30 mm	30 mm

AL blank

120011-04300 4.3 m

120011-05300 5.3 m

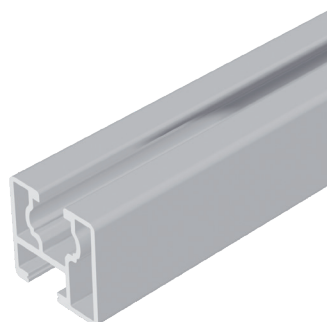

Module support profile Eco05

Mechanical connection

Upper: KlickNut M8
Lower: Screw channel M10

b	h
30 mm	30 mm

AL blank

120001-04300 4.3 m

120001-05300 5.3 m

MODULE SUPPORT AND MOUNTING PROFILES

Profiles

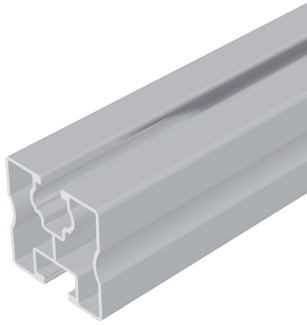

Module support profile Solo

Mechanical connection

Upper: KlickNut M8
Lower: Screw channel M10

b	h
40 mm	40 mm

AL blank

Black anodized

120005-02100	2.1 m		
120005-03200	3.2 m		
120005-04300	4.3 m	120005-94300	4.3 m
120005-05300	5.3 m	120005-95300	5.3 m
120005-006	6.0 m		
120005-06200	6.2 m		

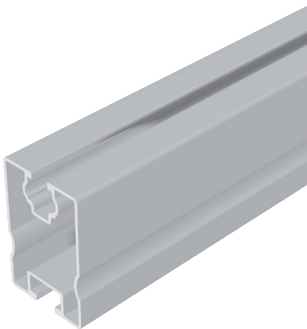

Module support profile SoloPlus

Mechanical connection

Upper: KlickNut M8
Lower: Screw channel M10

b	h
40 mm	60 mm

AL blank

120006-04300	4.3 m
120006-05300	5.3 m

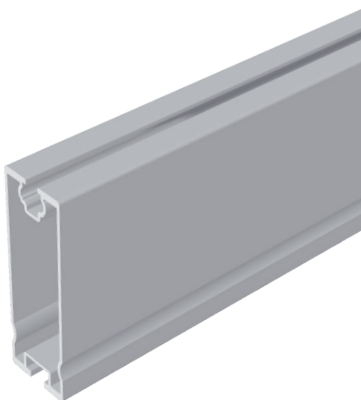

Solo XL module support profile

Mechanical connection*

Upper: KlickNut M8
Lower: Screw channel M10

b	h
40 mm	120 mm

AL blank

120015-05300	5.3 m
---------------------	-------

* The lower M10 screw channel is only suitable for connecting with square head bolt 943410-025. Not for Rapid cross connector, KlickTop or similar connections.

PROFILE ACCESSORIES

Profiles

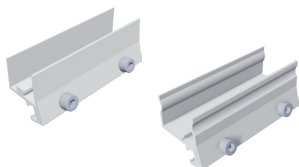

129001-003	E Eco connector, pre-assembled	PU:100
129002-002	E Solo, SoloPlus connector FixZ-7, FixZ-15, pre-assembled	PU:100



129001-004	Eco internal connector set	PU:50
-------------------	----------------------------	-------

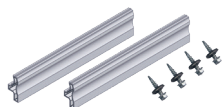

129060-001	Solo slide-in connector set	PU:50
-------------------	-----------------------------	-------



	AL blank	Black anodized	
129063-000	129063-900	Rapid cross connector Completely pre-assembled for Klicknut M8 for cross rail system See Rapid cross connector product sheet	PU:200

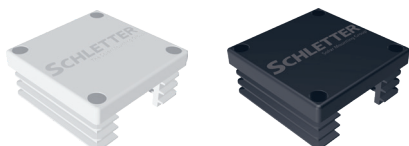

	Grey	Black	
129011-000	129011-900	Solo plastic end cap	PU:100

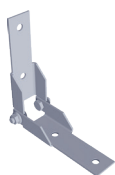

129061-001	Ridge connector set	PU:50
-------------------	---------------------	-------

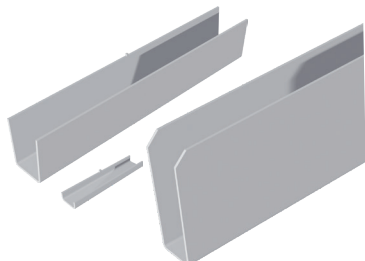

129001-007	SoloPlus internal connector	PU:25
129001-008	EcoLight internal connector	PU:25
129001-009	SoloXL internal connector set	PU:25



119033-002	Uno M8 universal adapter	PU:50
-------------------	--------------------------	-------

As clamp dowel for special applications in connection with the Eco05 module support profile the profile must be fastened with M8 screws to the clamp dowel



SUPPORTS

Flat roof supports - Beam kit

Flat roof support/Facade support - Beam kit

Beam kit accessories

Support accessories

FLAT ROOF SUPPORTS

Supports Beam kit

For all types of flat roof fasteners, depending on the substrate and fastener, diagonal reinforcement of the support units may be useful.

If necessary, these reinforcements can be built on site, e.g. using our punched mounting tape 16-50 m 119015-003.

Beam kit Angles of 15°- 40° in 5° increments possible

Flat roof support light 1,3m beam kit

	a	b	c	d	e
150002-130	1195 mm	1193 mm	810-850 mm	600 mm	997-1067 mm

For horizontal and vertical module mounting

Please note:

Refer to the dimension table for mounting areas, observe the specifications of the module manufacturer

Strut selection and accessories see page 46

Flat roof support light 1,5m beam kit

	a	b	c	d	e
150002-150	1445 mm	1193 mm	920-960 mm	690 mm	997-1067 mm

For horizontal and vertical module mounting

Please note:

Refer to the dimension table for mounting areas, observe the specifications of the module manufacturer

Strut selection and accessories see page 46

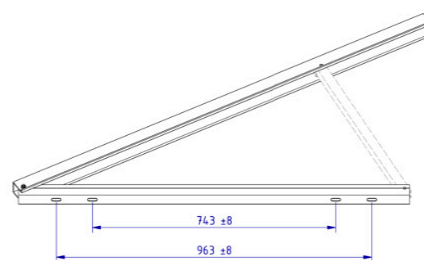
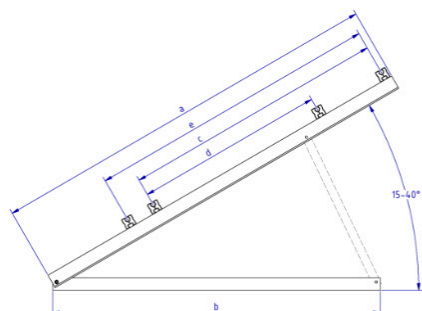

FLAT ROOF- AND FACADE SUPPORTS

Supports Beam kit

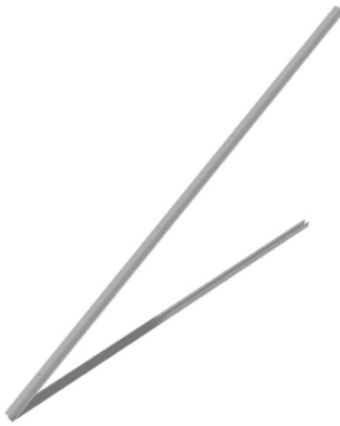

Beam kit

Angle available in 15° or 30°

Flat roof support light 3,2m beam kit

	a	b	c	d	e
155002-320	3195 mm	2635 mm	1080 mm	733 mm	1072 mm

For horizontal and vertical module mounting

Please note:

Refer to the dimension table for mounting areas, observe the specifications of the module manufacturer

Strut selection and accessories see page 46

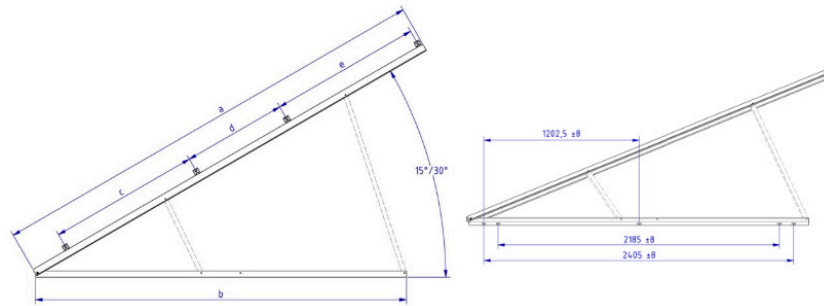

Facade support

Angles of 50°- 75° in 5° increments possible

Facade support light 1,3m beam kit

	a	b	c
156002-160	1285 mm	1323 mm	900 mm

For horizontal and vertical module mounting

Please note:

Refer to the dimension table for mounting areas, observe the specifications of the module manufacturer

Strut selection and accessories see page 46

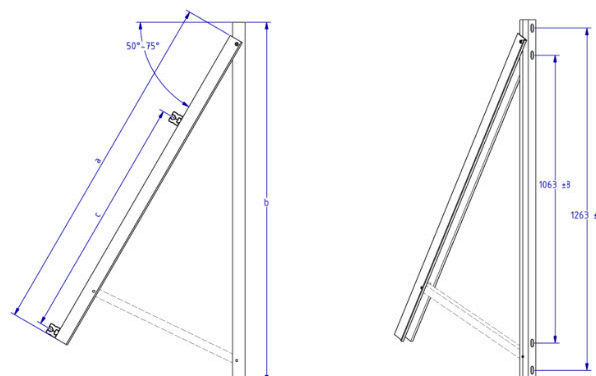

BEAM KIT ACCESSORIES

Supports

To complete the beam kits the following components such as struts and accessories are necessary!

Struts for beam kit

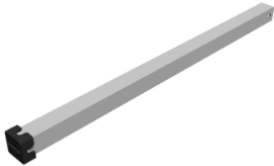

159005-001	Strut with end cap 338mm
159005-002	Strut with end cap 428mm
159005-003	Strut with end cap 520mm
159005-004	Strut with end cap 613mm
159005-005	Strut with end cap 700mm
159005-006	Strut with end cap 781mm
159005-007	Strut with end cap 1359mm



Beam kit accessories

943308-055	Bolt M8x55 hex socket DIN 912 GMB (2 piece/strut)	PU:100
943911-008	Nut M8 hexagon self-locking DIN985 A4 (2 piece/strut)	PU:500
943922-010	M10 Large Washer DIN9021 A2 (1 piece/screw-on point bottom support)	PU:100

Strut table

Flat roof support						
	15°	20°	25°	30°	35°	40°
150002-130	159005-001	159005-002	159005-003	159005-004	159005-005	159005-006
150002-150	159005-001	159005-002	159005-003	159005-004	159005-005	159005-006
155002-320	159005-005			159005-007		
	159005-001			159005-004		

Facade support						
	50°	55°	60°	65°	70°	75°
156002-160	159005-006	159005-005	159005-004	159005-003	159005-002	159005-001

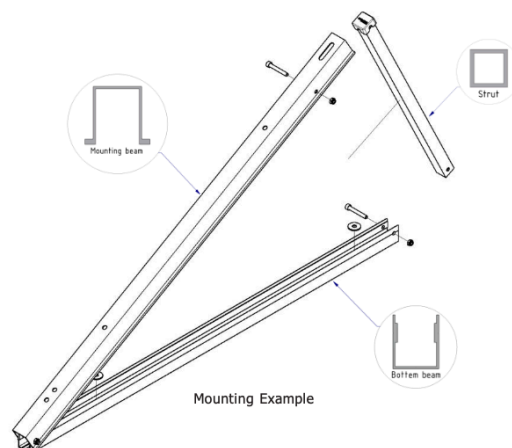

SUPPORT ACCESSORIES

Supports



Filling finish

159000-027 Concrete block filling finish set18	PU:100
---	--------

160002-001 SolRack AL (1 plate) Material thickness: 1 mm Surface: 0.55 m ²	
--	--



SolRack accessories

(2 units per plate required!)

943610-025 Screw M10 x 25 hexagonal DIN933 A2 GMB	PU:100
943922-010 Large washer M10 DIN9021 A2	PU:100
943912-010 Flange nut M10 with locking teeth DIN6923 A4	PU:100



Windsafe (depending on project)

Rear wall paneling for elevated PV systems to reduce wind loads

164160-180 Windsafe Vario AL 160 x 1830 mm	
164250-180 Windsafe Vario Alu 250 x 1830 mm	



LOAD-OPTIMIZED FLAT ROOF SYSTEMS

FixGrid

FlatGrid

FIXGRID

Load-optimized flat roof systems



FixGrid18

163000-201	FixGrid18 100 kit 6° set of 2
163000-202	FixGrid18 100 kit 6° set of 3
163000-203	FixGrid18 100 Kit 13° set of 2
163000-204	FixGrid18 100 kit 13° set of 3
163000-301	FixGrid18 South kit 6° set of 2
163000-302	FixGrid18 South kit 6° set of 3
163000-303	FixGrid18 South kit 13° set of 2
163000-304	FixGrid18 South kit 13° set of 3

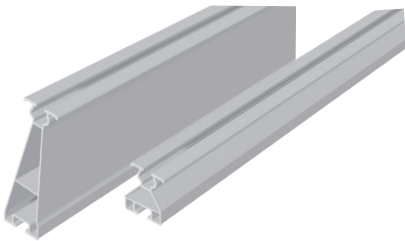

FixZ-7

121001-04300	FixZ-7 Upper system profile 4300 mm
121001-05300	FixZ-7 Upper system profile 5300 mm
121010-04300	FixZ-7 Lower system profile18 4300 mm
121010-05300	FixZ-7 Lower system profile18 5300 mm

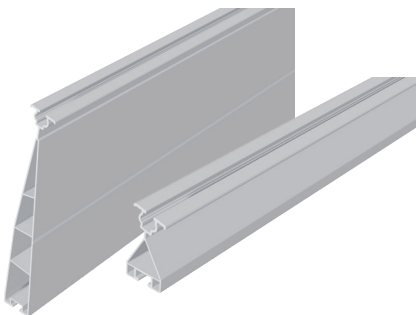

FixZ-15

121008-04300	FixZ-15 Upper system profile18 4300 mm
121008-05300	FixZ-15 Upper system profile18 5300 mm
121009-04300	FixZ-15 Lower system profile18 4300 mm
121009-05300	FixZ-15 Lower system profile18 5300 mm

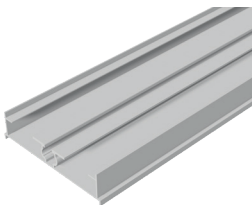

FlatGrid

FlatGrid

128039-006	Base profile for FlatGrid 6000 mm
128039-203	Base profile for FlatGrid 2150 mm
128039-212	Base profile for FlatGrid 2650 mm
128039-214	Base profile for FlatGrid 4200 mm
128039-215	Base profile for FlatGrid 6300 mm
128039-216	Base profile for FlatGrid 3150 mm

FIXGRID

Load-optimized flat roof systems

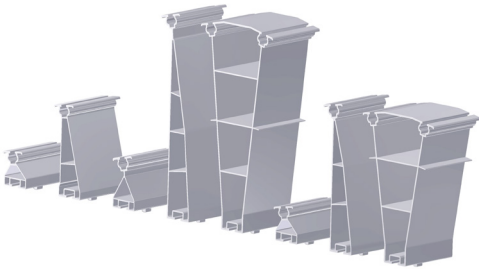

FixZ profile pieces incl. FixGrid screw-in connector

163900-011	FixZ-7 upper system profile 96 mm with connector	PU:25
163900-012	FixZ-7 lower system profile 96 mm with connector	PU:25
163900-021	FixZ-10 upper system profile 96 mm with connector	PU:25
163900-022	FixZ-10 lower system profile 96 mm with connector	PU:25
163900-023	FixZ-10 center system profile 96 mm with connector	PU:25
163900-001	FixZ-15 upper system profile 96 mm with connector	PU:25
163900-002	FixZ-15 lower system profile 96 mm with connector	PU:25
163900-003	FixZ-15 center system profile 96 mm with connector	PU:25

For high snow loads up to 5.4 kN / m²

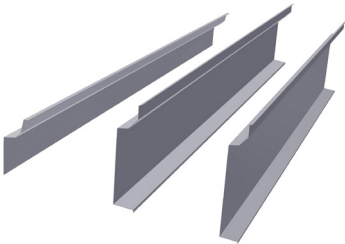

FixZ-7 Windsafe

169018-170	FixZ-7 Windsafe up to 1700 mm
169018-210	FixZ-7 Windsafe up to 2067 mm
169017-170	FixZ-10 Windsafe up to 1700 mm
169017-210	FixZ-10 Windsafe up to 2067 mm
169019-170	FixZ-15 Windsafe up to 1700 mm
169019-210	FixZ-15 Windsafe up to 2067 mm

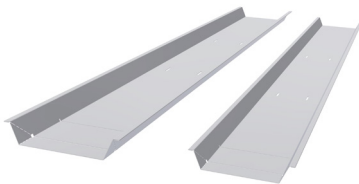

Ballast tray

169020-170	FixGrid ballast tray18 up to 1700 mm
169020-210	FixGrid ballast tray18 up to 2067 mm

The appropriate module clamps can be found in the module clamps section

FIXGRID

Load-optimized flat roof systems

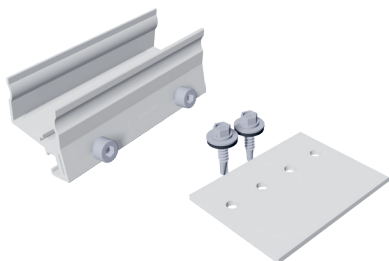

Connectors

129002-002	Connector E Solo, SoloPlus, FixZ-7, FixZ-15, pre-assembled	PU:100
129019-001	Additional connector for FixZ-15 upper set	PU:100

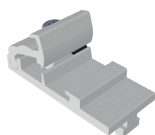

Other accessories

129063-000	Rapid cross connector	PU:200
129062-001	Tension connector set M8	PU:100
135003-005	Lightning protection clamp M8	PU:25
119015-002	Punched mounting tape 6mm - Reel á 50 m	PU:1
119015-003	Punched mounting tape 16mm - Reel á 50 m lightning resistant	PU:1

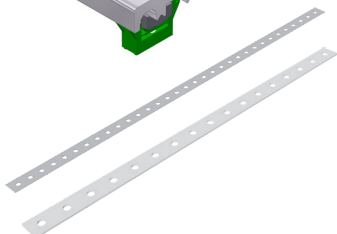
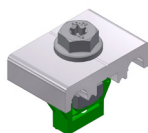
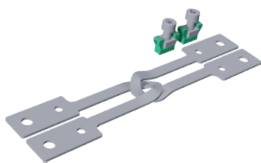

The appropriate module clamps can be found in the module clamps section, and the module support profiles in the profiles section

FLATGRID

Load-optimized flat roof systems

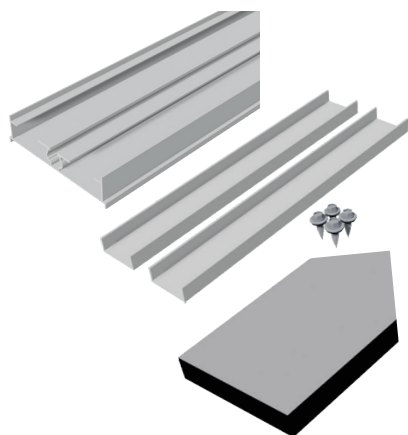

Base profile FlatGrid for structure protection strips

128039-006	Base profile for FlatGrid 6000 m	
128039-203	Base profile for FlatGrid 2150 m	
128039-212	Base profile for FlatGrid 2650 m	
128039-214	Base profile for FlatGrid 4200 m	
128039-215	Base profile for FlatGrid 6300 m	
128039-216	Base profile for FlatGrid 3150 m	
129078-000	Internal connector for FlatGrid set	PU:25
169004-003	Surface protect.mat 300x110x20mm SK cut	PU:25
169004-008	Surface protect.mat 300x110x20FH SK cut (On request, please note longer delivery time)	PU:25

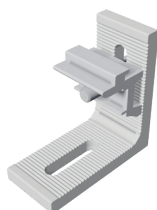

Rapid²⁺ L bracket connector and accessories

119026-001	Rapid ²⁺ L bracket connector	PU:100
943308-120	Allen screw M8 x 20	PU:100
943922-008	Washer M8	PU:100
943914-008	Square nut M8	PU:100
129010-008	Click-in module for nut M8	PU:100

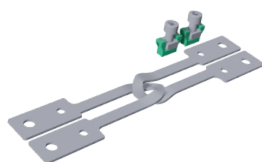

Other accessories

129062-001	Tension connector set M8	PU:100
169017-000	Additional tray	PU:50
169004-007	Structure protection mat 230 x 200 x 6	





PVMAX ENERGY-KITS

PVMax S Kit

PVMAX

New: PVMax-S Kit

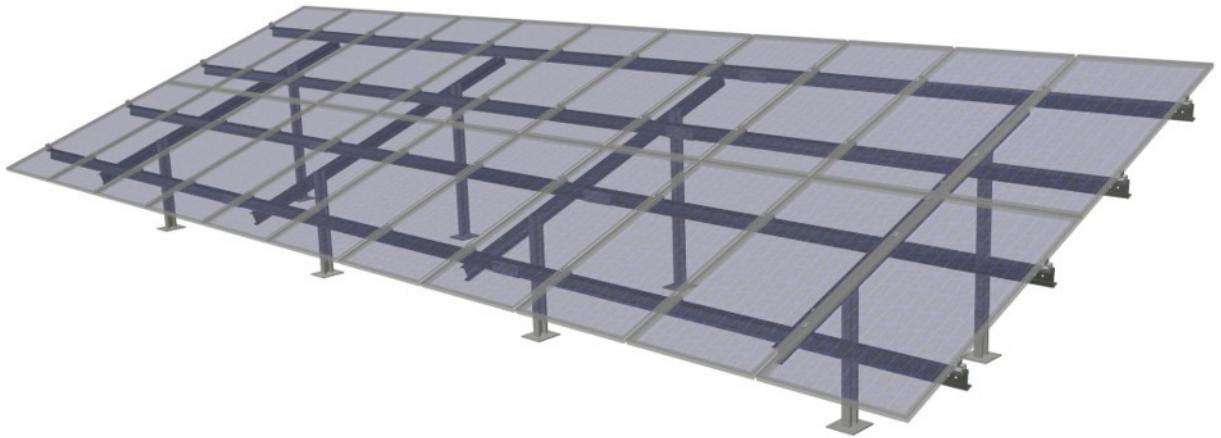

PVMAX

New: PVMax-S Kit

The new PvMax-S complements our product range from the FS steel family. PvMax-S combines FS Duo with concrete foundations and is ultimately a cost-effective steel variant of the PvMax3 made of aluminium.

- Quick and easy installation
- Complete statics verification
- Economical and efficient
- Applicable for 60 and 72 cell modules

Open area system with concrete foundation

146003-040 PVMaxS Kit 2V 11/72 4 posts



SCREWS AND SMALL PARTS

Screws and small parts

SCREWS AND SMALL PARTS

Screws and small parts



Hexagon screw, VA

943610-025 M10 x 25	PU:100
943610-030 M10 x 30	PU:100
943610-035 M10 x 35	PU:100
943610-045 M10 x 45	PU:100

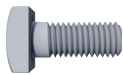

Square head screw, VA

943410-025 M10 x 25	PU:100
----------------------------	--------

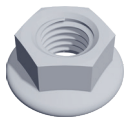

Flange nut with locking teeth

943912-008 M8	PU:100
943912-010 M10	PU:100



Washer large, VA

943922-008 M8	PU:100
943922-010 M10	PU:100



Allen screw

943308-120 M8 x 20 bottom gear teeth	PU:100
943308-135 M8 x 35 bottom gear teeth	PU:200

SCREWS AND SMALL PARTS

Screws and small parts



943914-008	Square nut M8, V4A Fits all Schletter system profiles, can be combined with Klicknut M8 and click-in component	PU:100
-------------------	---	--------

129010-008	Click-in module for nut M8 For simplified insertion of the M8 square nut at any location on the KlickIn nut M8	PU:100
-------------------	---	--------

943914-010	Square nut M10, V4A	PU:100
-------------------	---------------------	--------

943914-108	Special square nut M8, V4A (shape as in M10) Fits all Schletter system profiles, can be combined with Klicknut M10 and click-in components	PU:100
-------------------	---	--------

129010-001	KlickIn click-in module for nut M10 For simplified insertion of the M10 square nut at any location on the KlickIn nut M10	PU:100
-------------------	--	--------

Nut self-securing, V4A

943911-008	M8	PU:500
943911-010	M10	PU:200

Threaded screw, self-grooving, VA

For steel starting at 1.5 mm



943763-064	6,3 x 64	PU:100
943763-115	6,3 x 115	PU:100
943763-150	6,3 x 150	PU:100
943763-200	6,3 x 200	PU:50

SCREWS AND SMALL PARTS

Screws and small parts



Fastening screws for metal components and plates

943755-925	Drill screw 5.5 x 25 with gasket	PU:100
943000-360	Thin sheet metal screw 6.0 x 25 A2 with gasket	PU:100

943772-019	Repair screw 7.2 x 19 self-grooving FABA-A A2	PU:500
-------------------	---	--------

EPDM rubber inlay 3 mm self-adhesive, 50 m roll, UV-resistant

e.g. for trapezoidal sheet clamps or for laminate modules



973000-041	EPDM rubber self-adhesive 48 mm wide, reel 50 m
-------------------	---

Wood screw

For non-boarded roofs, we recommend at least 80 mm, for roofs with boarding and counter-battens, at least 120 mm!

Wood screw with plate head, VA



Example

943208-080	8 x 80	PU:100
943208-100	8 x 100	PU:100
943208-120	8 x 120	PU:50

Wood screw with plate head, galvanized

942208-080	8 x 80	PU:50
942208-100	8 x 100	PU:50
942208-120	8 x 120	PU:50

Seal for plate head screws



119016-000	dm 8 EPDM
-------------------	-----------

SCREWS AND SMALL PARTS

Screws and small parts

Cable routing

Cable fastener made of UV- and temperature-resistant plastic

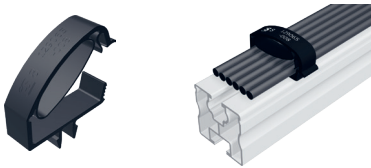

129065-008 Proklip-Multi 8

Profiles	Systems	Cable quantity	
Click or screw channel M8, module support profile S, module support profiles Solo, Eco05, FixZ-7, FixZ-15	FixZ-7, FixZ-15, system FS, carport, special projects	approx. 6*	PU:100

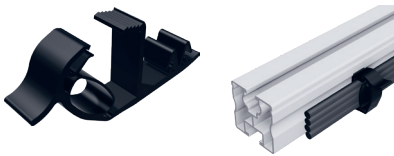

129065-001 Proklip-Multi 10S

Profiles	Systems	Cable quantity	
Solo and screw channel M10	-	approx. 4*	PU:100



149023-001 Mounting clips 1.0–3.0 mm, upper guide

Fastening on edges with a width of 1.0–3.0 mm; cable tie length: Cable tie length: 200 mm

PU:100



149023-002 Mounting clips 1.0–3.0 mm, lateral guide

Fastening on edges with a width of 1.0–3.0 mm; cable tie length: Cable tie length: 200 mm

PU:100

* Starting with a 6 mm² cable with a 6 mm cable diameter



For competent and comprehensive advice in planning your system, and for questions about logistics and order processing, our employees are gladly available to you.

SCHLETTER
The Solar Mounting Group

SCHLETTER SOLAR GMBH (Headquarters)
Alustraße 1
83527 Kirchdorf
GERMANY

www.schletter-group.com

We reserve the right to changes, including technical modification.